



Product Range

www.osbornerefrigerators.uk
sales@osborne-ref.co.uk

Contents

3	Osborne & The Environment
4-5	Upright Chillers
6-7	Standard Undercounter Chillers
8-9	Reduced-Height Undercounter Chillers
10	Slimline Undercounter Chillers
11	High Capacity Undercounter Chillers
12-13	Catering Chillers
14-19	Milk Chillers
20-21	Countertop Chillers
22-23	Pass-Through Chillers
24	Fish Keepers
25	Open Fronted Chillers
26	Top-Loading Chillers
27	Pharmacy / Special Build
28	Branding
29	Standard Options & Extras

Symbols



Fan cooled condenser
For efficient running



Maintenance-free condenser
For convenience and a long life



Fan blown evaporator
For fast cooling



Lockable door(s)



Automatic defrost
and re-evaporation
For convenience

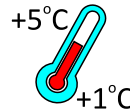

Temperature range



Digital Temperature
Controller



Accepts gastronorm trays



LED internal lighting
For ultra-low energy usage



Ideal for coffee machines
Designed for convenient milk storage

Osborne & The Environment

Manufacturing With A Conscience

Osborne Refrigerators have a long history of manufacturing with an environmental conscience. We have always used polystyrene insulation which is efficient and recyclable, rather than more damaging polyurethane or similar materials and each refrigerator we produce is designed so that it can be easily recycled at the eventual end of its life. We also design for a long life - some of the oldest refrigerators still working around the world are Osborne refrigerators. We were the first British manufacturer to move our entire production away from CFC based refrigerants and our R&D Department are constantly looking at the latest technologies available. Our **eCold** chillers, for example, feature LED lighting, low-voltage fan motors and improved insulation which combine to give huge cuts in running costs. All our chillers use R600a, an environmentally friendly hydrocarbon refrigerant.



British Designed & Built



Lots of companies claim to be British and many of them may indeed still design and distribute in the UK, but have manufacturing sourced in the Far East. Osborne Refrigerators still manufacture exclusively in the UK. By maintaining our manufacturing in modern and efficient facilities here, we avoid the environmental damage caused by inefficient third world factories and the pollution caused by shipping products in from thousands of miles away. We also stock spare parts to enable you to keep your Osborne cabinet working efficiently for many years.

Shrinking Our Carbon Footprint

In addition to limiting the impact we have on the environment, we maintain over 100 acres of West Sussex woodland which more than offsets all our CO₂ emissions from both manufacturing and distribution.



Green Reasons To Buy An Osborne Cabinet

- All Osborne cabinets can be recycled by us at the end of their life
- All packaging used is recyclable
- Wherever possible, all materials used to manufacture our chillers are recyclable (including the polystyrene insulation)
- All cabinets are designed for maximum energy efficiency without compromising cooling performance
- All Osborne cabinets are manufactured in the UK which means no environmental pollution from ships to bring them in from overseas

Upright Chillers

All our upright **eCold** chillers feature double glazed locking doors, LED internal lighting, digital temperature controller, fan assisted interior for fast temperature pull-down and fan cooled, maintenance-free condenser for superior performance. All models can be built in requiring only minimal airspace. Solid doors are available as an option. A range of painted and stainless steel finishes are available. Top mounted lightbox for branding is available as an optional extra for all models.

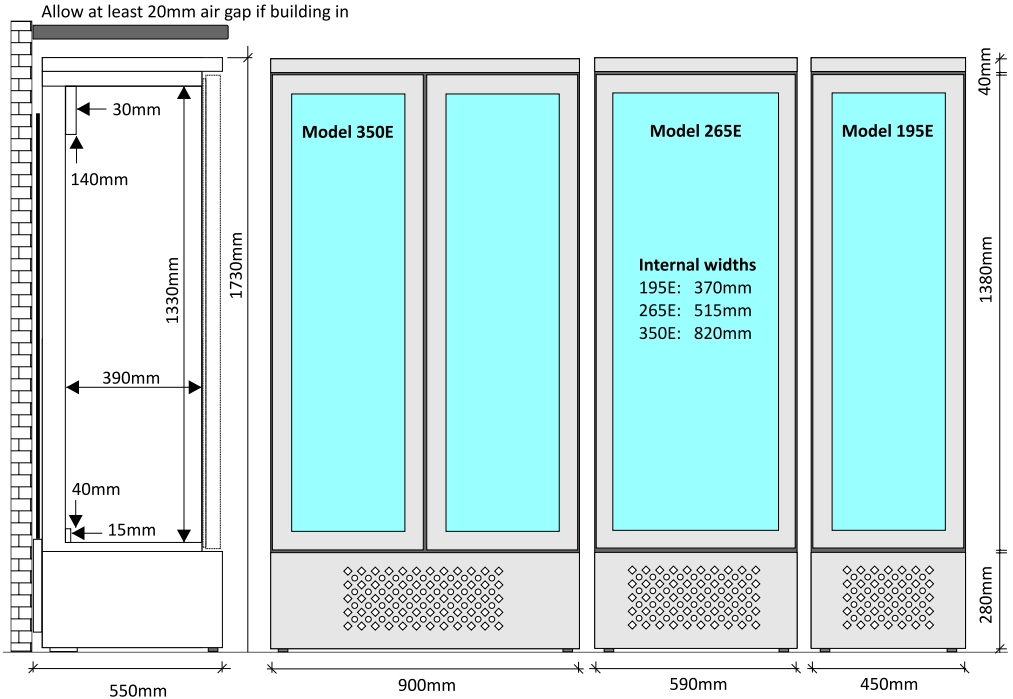

Model	Dimensions HxWxD mm	Capacity Nett litres	Bottle Capacities / Shelves	
			ES Version 33cl Bottle	EW Version 75cl Bottle
460ES	1420x1200x550	430	410 / 4	n/a
350ES	1730x900x550	420	403 / 5	144 / 12
600ES	1880x712x620	410	348 / 5	154 / 14
265ES	1730x600x550	267	240 / 5	108 / 12
230ES	1420x600x550	213	192 / 4	81 / 9
195ES	1730x450x550	190	180 / 5	72 / 12

Bottle capacities based on 330ml 236mm high beer bottles for ES models and 100mm dia 75cl wine bottles for EW models.

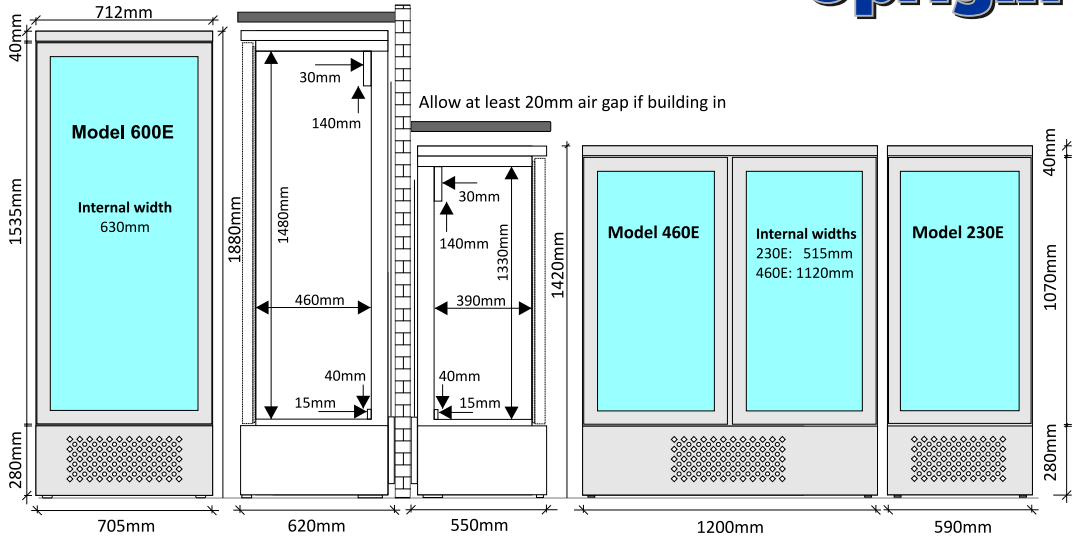

Cabinet Specifications



Features

- Fan assisted evaporator for rapid cooling
- Fan assisted, maintenance-free condenser
- Automatic defrost and re-evaporation
- Digital temperature controller
- LED lighting gives excellent product display
- Lockable double glazed door(s)
- ES models feature 5 flat shelves
- EW models feature 9-14 flat shelves

Options

- Solid door(s)
- Choice of colours
- Choice of black, brown or silver painted exterior
- Other colours to special order
- Stainless steel exterior and/or interior
- Stainless steel doorframes/solid doors
- 14 - 16°C temp range for red wine
- Topmounted lightbox (adds 180mm to height)



Undercounter

Standard Height Undercounter Chillers

All our undercounter **eCold** chillers feature double glazed locking doors, LED internal lighting, digital temperature controller, fan assisted interior for fast temperature pull-down and fan cooled, maintenance-free condenser for superior performance. All models can be built in requiring only minimal airspace. Solid doors are available as an option on all models and sliding doors are optional on the double door 250E. A range of painted and stainless steel finishes are available.

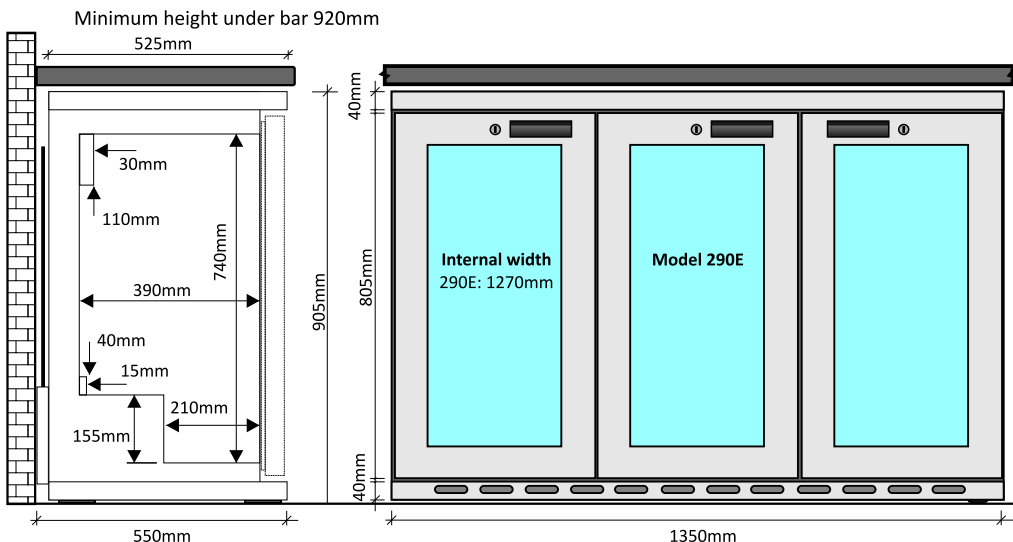

Model	Dimensions HxWxD mm	Capacity Nett litres	Bottle Capacities / Shelves	
			ES Version 33cl Bottle	EW Version 75cl Bottle
290ES	905x1350x550	330	291 / 2+base	100 / 5
250ES	905x900x550	220	197 / 2+base	66 / 5
180ES	905x600x550	139	120 / 2+base	50 / 5
50ES	905x493x550	110	105 / 2+base	40 / 5

Bottle capacities based on 330ml 236mm high beer bottles for ES models and 100mm dia 75cl wine bottles for EW models. Highest wine bottle capacity is reached with bottles standing on base and only 4 shelves used to lay bottles down.

Undercounter

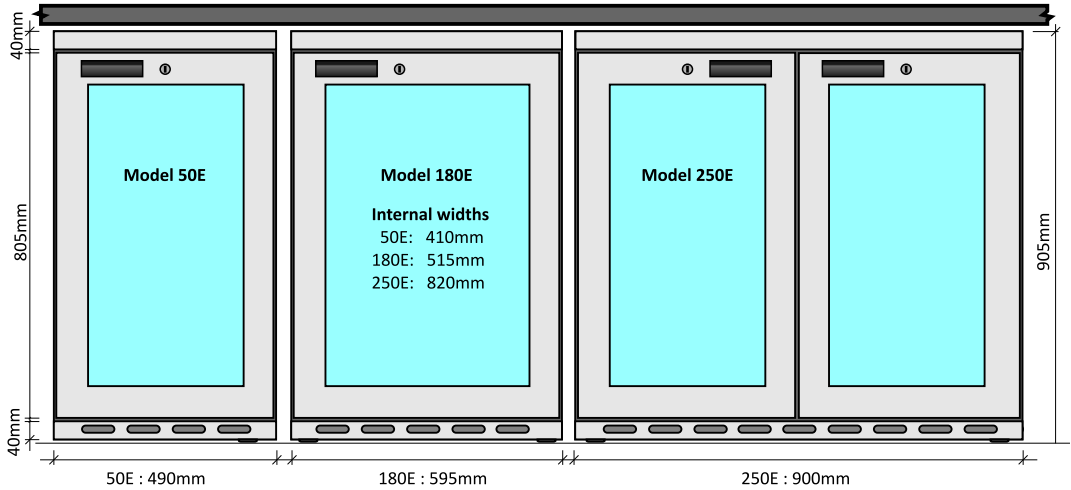

Cabinet Specifications



Features

- Fan assisted evaporator for rapid cooling
- Fan assisted, maintenance-free condenser
- Automatic defrost and re-evaporation
- Digital temperature controller
- LED lighting gives excellent product display
- Lockable double glazed door(s)
- ES models feature 2 flat shelves per door
- EW models feature 5 flat shelves per door

Options

- Slimline depth - 480mm (180E & 250E only)
- Super-Slimline Depth - 420mm (50E only)
- Solid door(s)
- Sliding doors (250E only)
- Choice of black or silver painted exterior
- Other colours to special order
- Stainless steel exterior and/or interior
- Stainless steel doorframes/solid doors
- 14 - 16°C temp range for red wine



Undercounter

Reduced Height Chillers

Our range of reduced height chillers gives you the flexibility to place an Osborne cabinet where others simply won't fit. They have been designed to suit situations where available height is limited. Available in the same 1350, 900, 600 and 493mm widths as the standard chillers, they are only 805mm high but still have all the features and options of the full size equivalents.

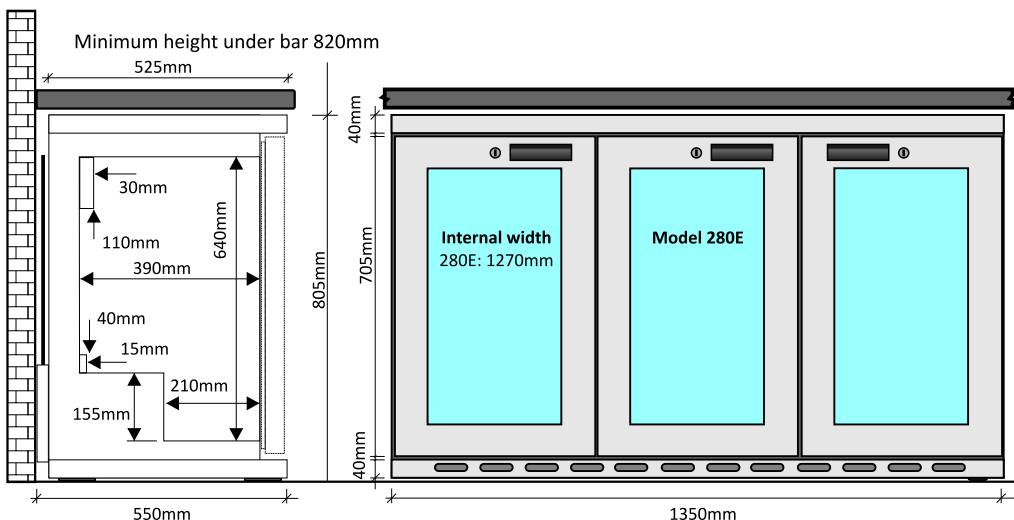

Model	Dimensions HxWxD mm	Capacity Nett litres	Bottle Capacities / Shelves	
			ES Version 27.5cl Bottle	EW Version 75cl Bottle
280ES	805x1350x550	281	290 / 2+base	72 / 4
220ES	805x900x550	188	200 / 2+base	58 / 4
160ES	805x600x550	110	120 / 2+base	38 / 4
30ES	805x493x550	94	105 / 2+base	33 / 4

Bottle capacities based on 275ml 206mm high beer bottles for ES models and 100mm dia 75cl wine bottles for EW models. Highest wine bottle capacity is reached with bottles standing on base and only 3 shelves used to lay bottles down.

Undercounter

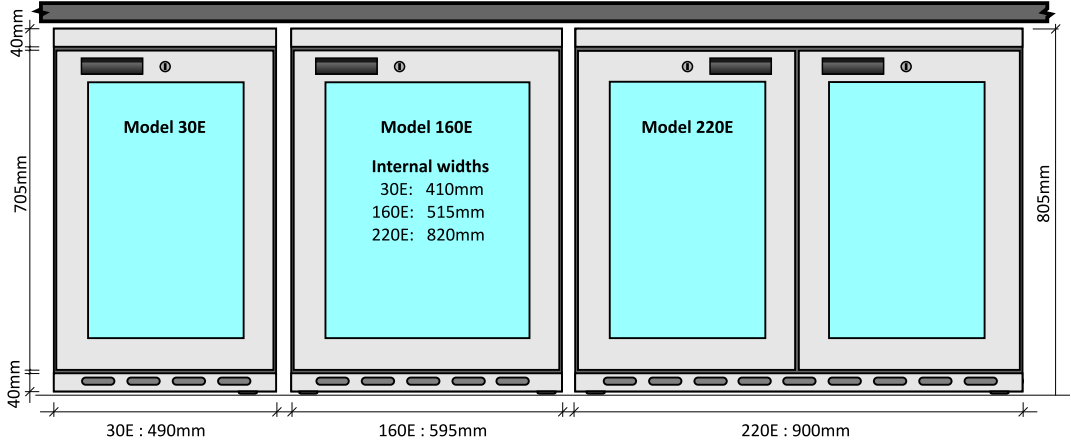

Cabinet Specifications



Features

- Fan assisted evaporator for rapid cooling
- Fan assisted, maintenance-free condenser
- Automatic defrost and re-evaporation
- Digital temperature controller
- LED lighting gives excellent product display
- Lockable double glazed door(s)
- ES models feature 2 flat shelves per door
- EW models feature 4 flat shelves per door

Options

- Solid door(s)
- Sliding doors (220E only)
- Choice of black or silver painted exterior
- Other colours to special order
- Stainless steel exterior and/or interior
- Stainless steel doorframes/solid doors
- 14 - 16°C temp range for red wine



Slimline Chillers

Three of our standard height chillers are also available in a slimline version, ideal for situations where space is more limited. The same range of painted and stainless steel finishes is available. The 250E (available with hinged or sliding doors) and 180E models (hinged doors only) have a reduced depth of 480mm. The 50E model is a super-slim 420mm deep.

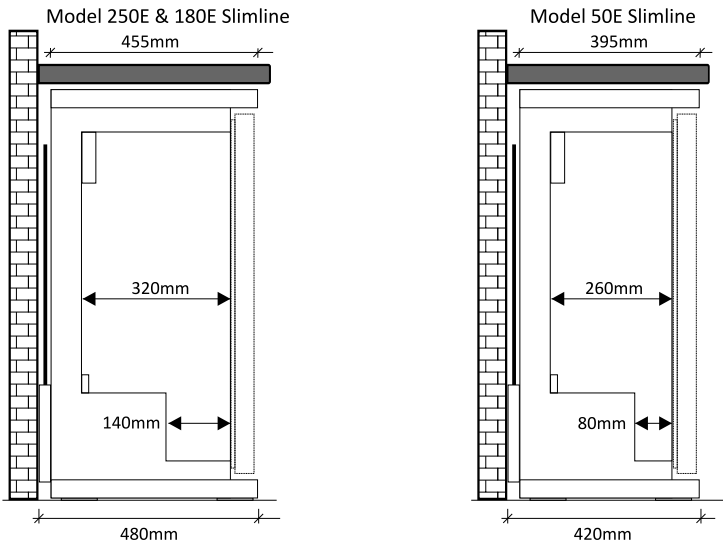

Internal dimensions the same as for standard models unless stated above

Model	Dimensions HxWxD mm	Capacity Nett litres	Bottle Capacities / Shelves	
			ES Version 33cl Bottle	EW Version 75cl Bottle
250ES SLIM	905x900x480	177	172 / 2+base	30 / 5
180ES SLIM	905x600x480	112	96 / 2+base	25 / 5
50ES SLIM	905x493x420	71	60 / 2+base	n/a

Maximum wine bottle height 300mm on slimline versions

Bottle capacities based on 330ml 236mm high beer bottles for ES models and 100mm dia 75cl wine bottles for EW models. Highest wine bottle capacity is reached with bottles standing on base and only 4 shelves used to lay bottles down.

High Capacity Chillers

Our high-capacity undercounter chillers feature end-mounted units with front access for easy maintenance. Both feature double glazed locking doors, LED internal lighting, digital temperature controller, fan assisted interior for fast temperature pull-down and fan cooled condenser for superior performance. The refrigeration is housed to the left as standard but both models can be manufactured with the unit on the right hand end (minimum order quantity may apply). Both models can be built in leaving only the front clear. Solid doors are available as an option. Sliding doors are available as an option on 4200. A range of painted and stainless steel finishes are available.

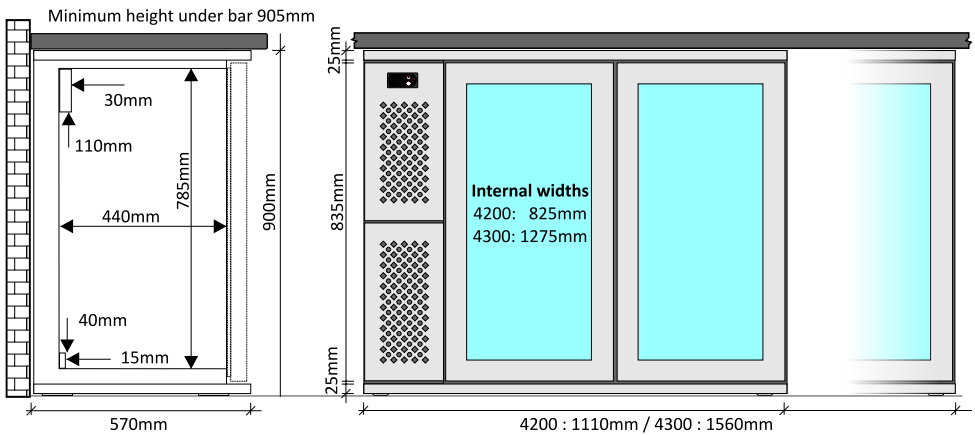

Models 4200 & 4300 both available with reversed layout

Model	Dimensions HxWxD mm	Capacity Nett litres	Bottle Capacities / Shelves	
			ES Version 33cl Bottle	EW Version 75cl Bottle
4300S	900x1560x570	435	431 / 3	108 / 6
4200S	900x1110x570	290	284 / 3	72 / 6

Bottle Capacities are based on 330ml x 236mm high for beer or 750ml x 100mm dia for wine

Catering Chillers

Our reduced height (805mm) **eColdN** catering cabinets are available in four different widths, from 493mm to 1350mm. They are designed primarily for the storage of foodstuffs and bottled beverages and are perfect for cafés, kiosks, retail restaurant areas - anywhere where space is at a premium. All models are manufactured from stainless steel with a stainless steel interior. Refrigerator interiors are fan assisted for enhanced chilling and the maintenance-free condenser is fan-cooled for increased efficiency. The insulation is increased over the standard **eCold** range and a fan-cut switch activates when a door is open. Refrigerator models feature automatic defrost. Freezers use cold-wall cooling and are manual defrost. Insulation is environmentally friendly polystyrene and the refrigerant is R600a hydrocarbon. Standard solid doors are hinged and lockable. Single door cabinets are also available as ambient storage cupboards to match.

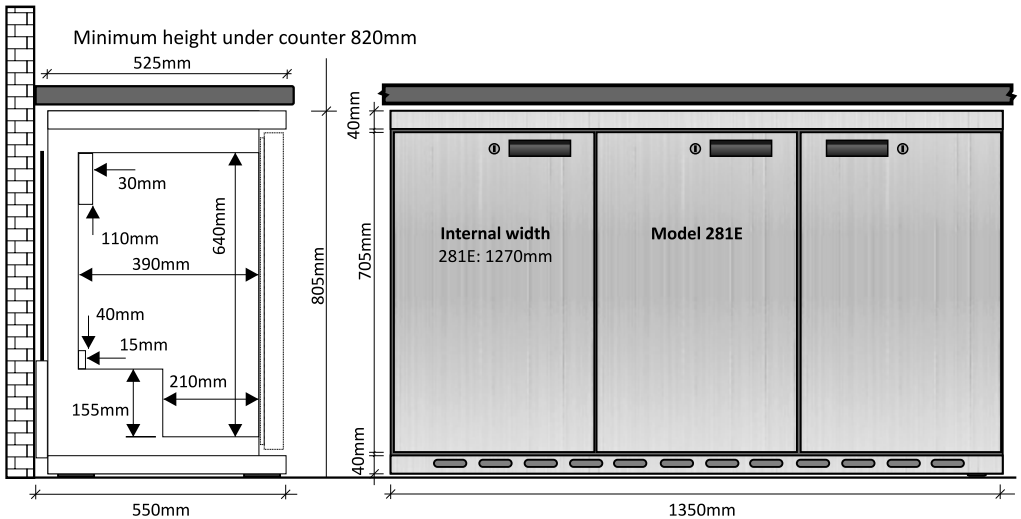

Model	Dimensions HxWxD mm	Temp Range	Capacity (litres) / Shelves
281ES	805x1350x550	+1 / +5	242 / 2+base
221ES	805x900x550	+1 / +5	155 / 2+base
161ES	805x600x550	+1 / +5	94 / 2+base
161EF	805x600x550	-18 / -25	94 / 2+base
31ES	805x493x550	+1 / +5	73 / 2+base
31EF	805x493x550	-18 / -25	73 / 2+base

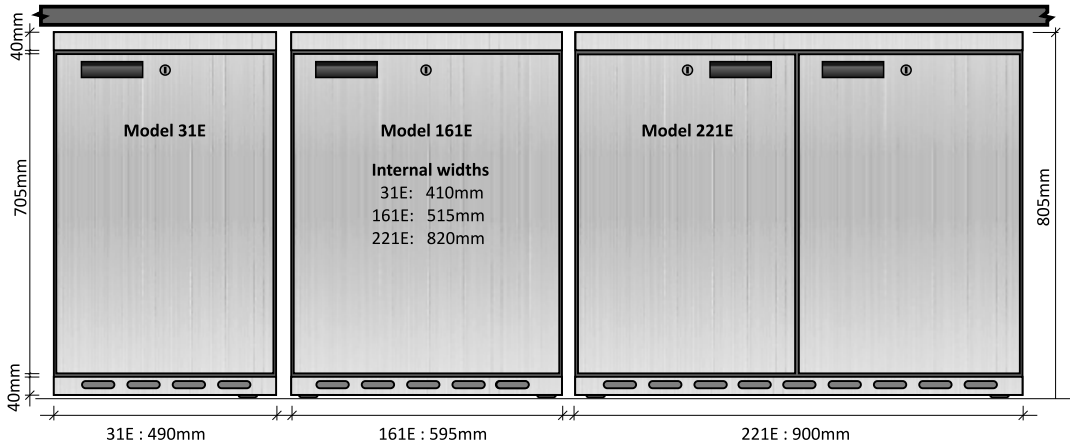

Cabinet Specifications



Features

- Fan assisted evaporator for rapid cooling*
- Fan assisted, maintenance-free condenser for efficient performance
- Automatic defrost and re-evaporation*
- Evaporator fan cut-out door switch*
- LED lighting* & low voltage fans
- Locking hinged doors
- Stainless steel exterior and interior

*except 31EF & 161EF freezers
Static cold-wall cooling, manual defrost
No LED lighting

Options

- Castors (add 120mm to height)
- 14 - 16°C temp range for red wine
- Ambient cupboard (31E and 161E only)



Milk Chillers

An Osborne milk chiller is the perfect solution for your coffee machine

Our range of specialist milk chillers has been designed in conjunction with several leading coffee machine manufacturers and coffee retailers to exacting requirements. They provide the consistent and reliable refrigeration needed for fresh milk while using the minimum of energy. Ultra low energy LED lighting and low voltage fans are fitted as standard and they can all be adapted to specific requirements e.g. milk pipe positions (minimum order quantities apply).



The MM3M showing in standard configuration with 3 into 1 milk tube. Black finish is standard.

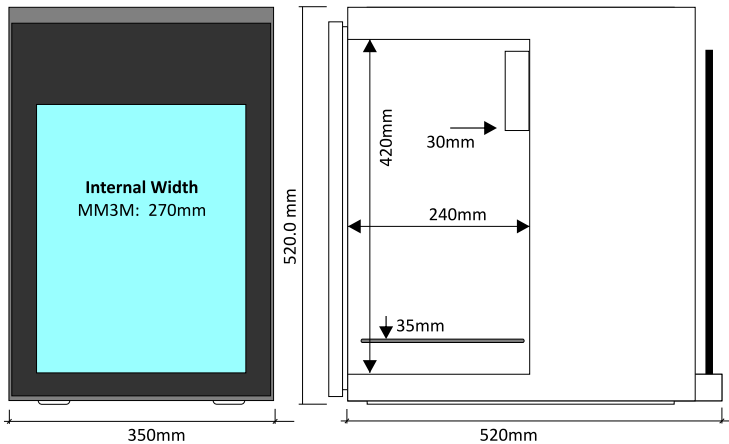

The MM3M is our most popular milk chiller. It is designed to take three 6 pint milk bottles but with a slightly different shelf arrangement will also accept a 13.6ltr pergal. It's compact size allows it to be positioned easily. The slightly larger MM4M will accept a 17 litre container for extended continuous operation. LED lighting is fitted as standard and various options are available including:

- Solid or glass door
- Hole for milk pipes (either side or top)
- Pipes for connection to an external pump

Model	Dimensions HxWxD mm	Capacities	
		Milk	Nett litres
MM4M	520x425x580	1 x 17ltr container	44
MM3M	520x350x520	3 x 3.41ltr btl / 1 x 13.6ltr "pergal"	23

Milk Chillers



The MM4M showing 15l container and pump housing (both supplied by others). Black finish is standard.

All our milk chillers are designed to store milk at the perfect temperature in the most convenient manner possible. They can be used in a variety of different ways, whether placed next to a coffee machine, underneath it or integrated into a larger piece of equipment. Our flexibility means that we can manufacture the chillers with holes for milk pipes in the most convenient positions to suit your requirements. The models included here are a fairly representative selection of the models we currently manufacture but, if they don't match your requirements, we can also, subject to quantities required, alter models to suit or design a new model to meet your specifications.

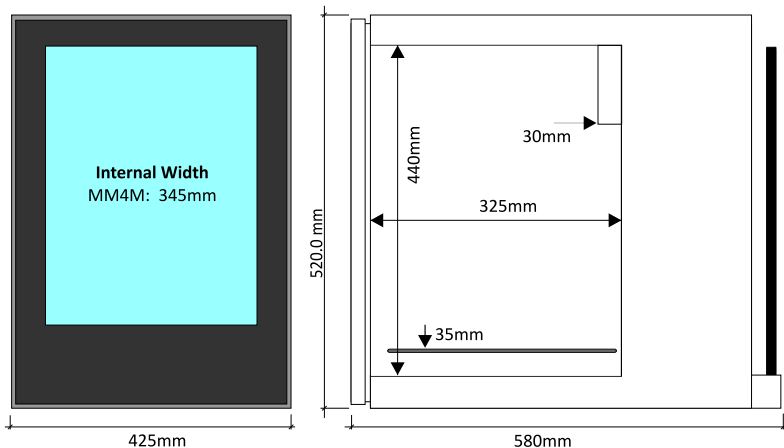

Milk Chillers



**MM3M with either glass or solid door
in silver painted finish**

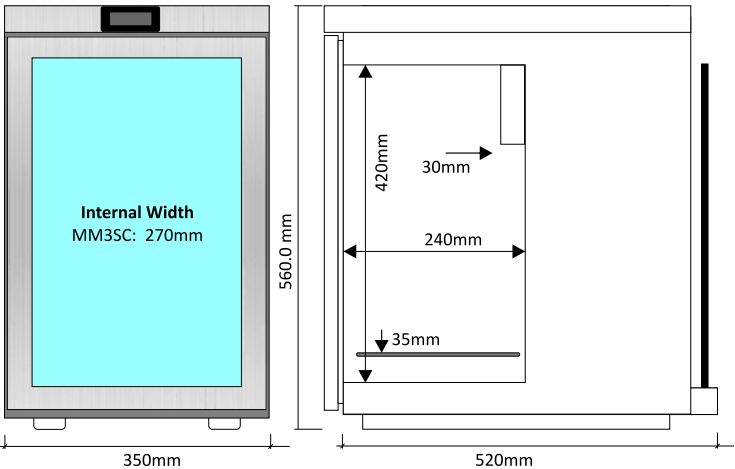

MM2SC with either glass or solid door

Details

The MM3M/MM3SC has been adapted into a variety of different cabinets and there is now a complete range of similar cabinets available which should fit almost any space requirement. All are available with a glass door as standard or solid door as an option.

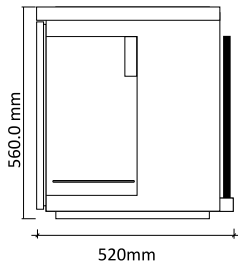
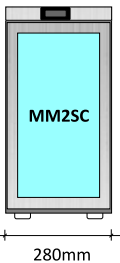
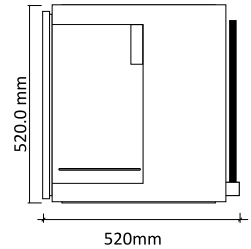
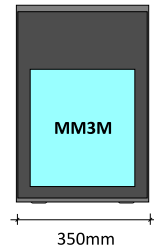
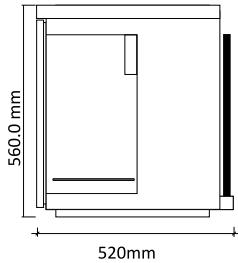
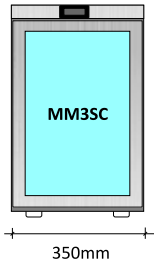
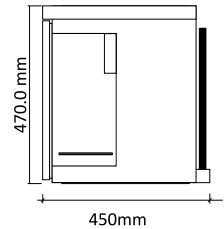
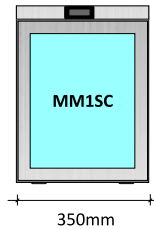
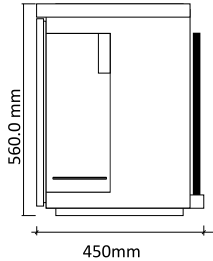
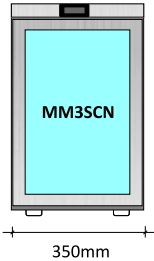

Model	Dimensions HxWxD mm	Capacity Nett litres	Shelves
MM3SC	560x350x520	23	1
MM3SCN	560x350x450	16	1
MM2SC	560x280x520	17	1
MM1SC	470x350x450	13	1

Milk Chillers

As they are used with milk, they tend to be supplied with stainless steel interiors as opposed to the aluminium of our standard cabinets. Various options are available including:

- Painted or stainless steel exterior finish
- Piped milk delivery systems for connection to internal or external pumps
- Self-closing doors
- Audible alarms for door openings and high temperature

Details

The FMC6 is a compact chiller designed to sit alongside a coffee machine. It takes a nine litre milk container and holes for pipes can be positioned on either side. A cold wall refrigeration is used which features a fan cooled condenser for efficient running. Construction is stainless steel throughout.



FMC6



MM105M



Shows milk pergal and milk delivery pipes plus internal pump (all supplied by others)

Details

Our MM105M is a larger, double-door chiller specially designed to take two 3 gallon "pergals" to give either high capacity for extended serving, or flexibility for storing two different types of milk.

Model	Dimensions HxWxD mm	Capacities	
		Milk	Nett litres
MM105M	510X680X650	1 x GN1 container / 2 x 13.6ltr "pergal"	81
FMC6	540x225x465	1 x 6ltr container	11

Milk Chillers

Details

The CM1M is an ultra-compact chiller designed to fit next to a coffee machine. Ultra low energy LED lighting is fitted as standard and various options are available including

- Solid or glass door
- A piped milk delivery system for connection to an external pump
- Digital controller
- Quick-view temperature indicator
- R600a hydrocarbon refrigerant



NB: Shown with optional solid door and quick-view temperature indicator



CM1M



NB: Shown with optional solid door and digital controller

Accepts 200mm 1/6 gastronorm container

Model	Dimensions HxWxD mm	Capacities	
		Milk	Nett litres
CM1M	415X270X415	1 x GN1/6 pan (3ltr)	15

Milk Dispenser

Details

Our compact chilled milk dispenser is finished in stainless steel (painted version available on request). Accepts standard size milk dispense boxes (13.6 litre). Door and serving panel can be branded for extra impact.

Model	Dimensions HxWxD mm	Capacities
		Milk
DA15Y	680x365x385	1 x 13.6ltr (3 gallon) "pergal"

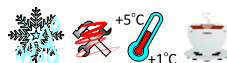

DA15Y

Countertop

Details

Our countertop range is designed for high impact sales and the cabinets are ideal for branding to give an extra boost for promotions or new products. All of our countertop chillers feature double glazed doors, low energy LED lighting for the interior and top panel, fan assisted interior for fast temperature pull-down and fan cooled condenser for superior performance. The BB90 and BB60 models can be wall mounted. Solid doors are available as an option. A range of painted and stainless steel finishes are available. The smaller BB50 and BB30 models are usually available to special order only.



BB90

BB60



Model	Dimensions HxWxD mm	Capacity Nett litres	Bottle Capacities / Shelves 33cl Bottle
BB90	806x605x435	76	62 / 2
BB60	806x495x510	75	68 / 2
BB50	806x390x510	56	55 / 2
BB30	806x365x435	41	34 / 2

NB: Bottle capacities are based on 330ml x 236mm high beer bottles

NB: BB50 and BB30 available to special order only

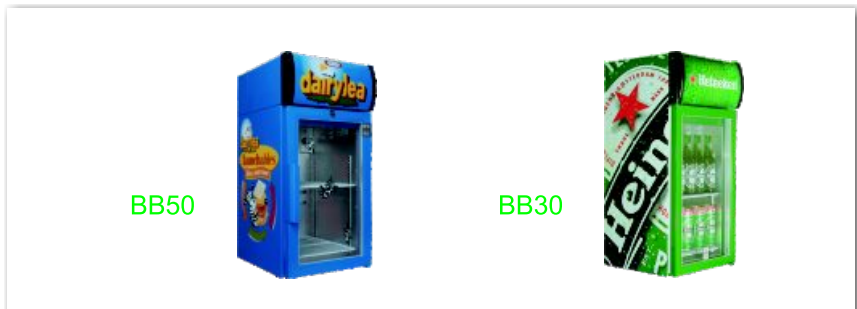

BB50

BB30

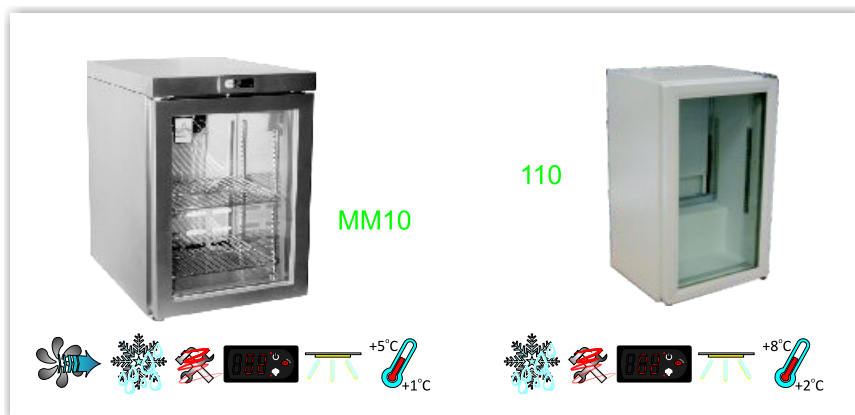

Model	Dimensions HxWxD mm	Capacity Nett litres	Bottle Capacities / Shelves 33cl Bottle / Can
MM10	690x500x530	62	56 bottles / 2
MM9	570x500x460	40	54 cans / 2
110	635x365x370	31	25 bottles / 1 + base

**NB: Capacities are based on 330ml x 236mm high for bottles or 330ml x 115mm high for cans
MM10 & MM9 will also take either 12 standard wine bottles or 8 champagne bottles.**



Details

The MM2SC and MM3SC are compact service cabinets designed to give foodsafe storage where space is at a premium. Standard finish is stainless steel interior and exterior. The latest generation of LED lighting is fitted as standard, in addition to low-voltage fan motor and electronic temperature control, giving the lowest possible energy usage without compromising excellent cooling performance.



Model	Dimensions HxWxD mm	Capacity Nett litres	Shelves
MM3SC	560x350x520	23	2
MM2SC	560x280x520	15	2

Pass-Through

Details

Upright and undercounter pass-through refrigerators designed either for back-loading or double sided use in island bars. Both models feature double glazed locking doors, digital temperature controller, LED internal lighting, fan assisted interior for fast temperature pull-down and fan cooled condenser for superior performance. Both models can be built in leaving only the front clear, or built into the side of a coldroom, for backfilling with ready-chilled stock. The 7050 can be fitted with solid or glass hinged doors to front and rear. The 276E can also be fitted with sliding doors (at additional cost) to either the front or rear (not both sides). Both models can be fitted with a solid fixed back for use as a conventional double door refrigerator and, additionally, the 276E can be fitted with a fixed glass display panel to allow serving from the serving side and viewing only for the customer. The panel is hinged so that it can be opened for cleaning purposes. A range of painted and stainless steel finishes are available. A top mounted lightbox for branding is available as an optional extra (fits both models).

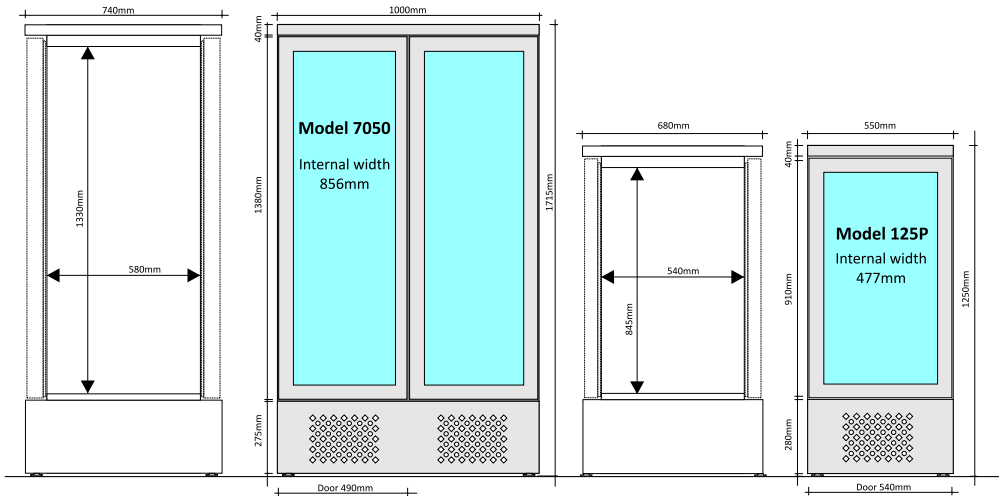

Model	Dimensions* HxWxD mm	Capacity Nett litres	Bottle Capacities / Shelves 33cl Bottle
7050	1720x1000x740	720	682 / 5
276E	900x1000x740	267	240 / 2
276E Slim	900x1000x560	190	180 / 2
125P	1200x550x690	150	135 / 3

NB: Bottle capacities are based on 330ml x 236mm high beer bottles

Sliding doors on 276E are available to front OR rear, NOT both sides

***Height does not include adjustable feet which add 10-20mm to overall height**

Pass-Through

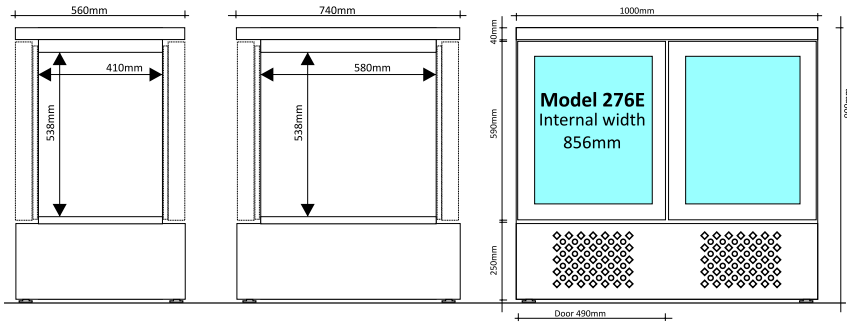

276E in stainless steel finish with glass front & rear

7050E in white painted finish (cost option) with solid rear doors



125P in silver painted finish with glass front & rear



Features

- Fan assisted evaporator for rapid cooling
- Fan assisted, maintenance-free condenser
- Automatic defrost and re-evaporation
- Digital temperature controller
- LED lighting gives excellent product display
- Lockable double glazed door(s)

Options

- Choice of black or silver painted exterior
- Other colours to special order
- Stainless steel exterior and/or interior
- Stainless steel doorframes/solid doors
- Solid door(s)
- Fixed glass front or rear (276E only)
- Sliding doors front OR rear (276E only)
- 14 - 16°C temp range for red wine
- Topmounted lightbox (adds 180mm to height)

Fish Keepers

Details

These wet fish storage refrigerators have coiled wall refrigeration designed to maintain the freshness of fish by providing optimum storage conditions with minimum dehydration. Standard finish is stainless steel exterior and interior. Supplied with 1/1 gastronorm stainless steel containers fitted with perforated inserts. A drain is fitted to the base of the refrigerator (ends in 3/4" BSP connection for easy attachment to a drain pipe). Internal tray supports are fully adjustable and removable for easy cleaning. OC150 is fitted with castors as standard and can be fitted to the OC80 at extra cost.

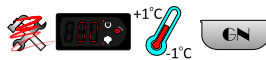

Model	Dimensions HxWxD mm	Containers 1/1 Gastronorm	Drawer Capacity Nett litres
OC150	1470x530x700	4 x 150mm + 3 x 100mm	122
OC80	900x530x700	1 x 150mm + 3 x 100mm	61

Details

Our open fronted display chillers can go where few have gone before. With a slimline depth of only 500mm and a width as narrow as 450mm, they offer a fantastic display opportunity with a minimum footprint area. This makes them perfect for impulse and promotional sales in high traffic areas where space is at a premium. Our open fronted chillers have been designed to offer good branding opportunities so that they can give maximum impact. Even if the sides are not visible, there is a large panel at the front ideal for branding and also a slim panel above the opening.

Our open fronted chillers are built to the same exacting standards as all Osborne chillers. They are available in both stainless steel and painted finishes, feature a digital temperature controller and are fitted with a nightblind and full length LED lighting for more environmentally friendly operation.



Model	Dimensions HxWxD mm	Shelves	Capacities Bottles / Shelf Area
OD600	1940x600x500	5	200 / 0.75m ²
OD450	1940x450x500	5	150 / 0.53m ²

Top Loading

Details

All our top loading chillers feature fan assisted interiors for fast temperature pull-down and fan cooled condenser for superior performance. All models can be built in leaving only the front clear. Standard exterior finish on all models is stainless steel for durability; other painted finishes are available. All models are available with a fitted speed rail at extra cost (as illustrated on TL90) and castors at extra cost.



Model	Dimensions HxWxD mm	Lids	Capacities Bottles / Cans / Nett litres
TL120	900x1200x500	2	270 / 342 / 210
TL90	900x900x500	2	207 / 300 / 157
TL60	900x600x500	1	132 / 168 / 96

NB: Capacities are based on 330ml x 236mm high for bottles or 330ml x 115mm high for cans

Pharmacy / Medical

In addition to our standard chillers, which we keep most varieties of in stock, we also manufacture specialist refrigerated cabinets for a variety of applications, including pharmacy / medical cabinets. All our standard upright and undercounter chillers can be manufactured to an enhanced specification for pharmacy applications. This includes audible alarms for extended door opening and for high / low temperature events. Solid doors are standard although glass doors are still available as a no-cost option.

Minimum order quantities may apply.

Although we have a wide variety of cabinet sizes and types available, we also have the facility to build bespoke solutions (subject to quantity). If you don't see what you need, we can probably still help you. Many of our current production cabinets were developed to meet specific customer requirements.

Minimum order quantities will apply.

Other Options / Specialist



'Mirror' stainless steel interior, and coloured lighting

Drawer options for catering chillers



Meet the CC1 from Osborne Refrigerators, the perfect alternative to an ice bucket. Professional grade gel cold packs keep your bottle of wine or champagne perfectly chilled for over 8 hours, the double glazed panel displays the contents for all to see and no ice means no drips. The bottle stays dry so there is no mess created by melting ice and no labels peeling off.

The CC1 is ideal for pubs, restaurants, bars, anywhere that serves wine by the bottle or, with alternative freezer packs, it can be used for serving ice-cold spirits at the table. It can also add an extra touch to room service for that special bottle of fizz .

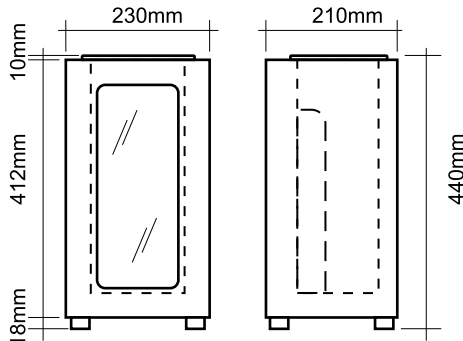

Perfect For Product Promotion

Branding

There is no doubt that a well branded chiller can increase sales and brand awareness and if you have a premium brand, you should have a premium quality chiller to promote it. Our chiller cabinets provide the perfect opportunity to promote a brand. There is a variety of ways in which our chillers can be branded and because all the manufacturing and branding is done in-house, we can be very flexible. This can be especially beneficial for new brands or small promotions because we can help you even if you only need small quantities. Contact the Sales Office and find out how our products can help your products stand out from the crowd.



Make your product stand out even without branding. A wide range of colours is available across most ranges.



Colours shown are for illustration purposes only and may not match actual paint colours. Wide range of Pantone / RAL colours available. Standard colours are black, brown and silver. Minimum order quantities and additional charges may apply to other colour choices

Cabinet Range

Optional Features / Extras

Upright Chillers

and

Undercounter Chillers

Stainless steel exterior and/or interior
 Stainless steel doors only (frames or solid)
 Sliding lockable doors (undercounter only, not all models)
 Solid locking doors
 Coloured internal lighting
 Lightbox (adds 180mm to overall height)
 Castors (undercounter only, add 120mm to height)

Catering Chillers

Glass doors
 Refrigerated drawers
 Castors (add 120mm to height)

Milk Chillers

Stainless steel exterior
 Hole for milk tube(s), position to suit
 Milk delivery tube set

Countertop Chillers

Stainless steel exterior and/or interior
 Stainless steel doors only (frames or solid)
 Coloured painted interior
 Coloured internal lighting
 Solid door

Pass-Through Chillers

Stainless steel exterior
 Stainless steel doors only (frames or solid)
 Sliding lockable doors (276E front or rear only, not both)
 Solid locking doors
 Solid fixed back
 Fixed glass panel (276E only)
 Lightbox (adds 180mm to overall height)
 Castors (276E only, add 120mm to height)

Fish Keepers

Alternative tray layout
 Castors on OC80 (add 120mm to height, standard on OC150)

Open Fronted Chillers

Stainless steel exterior
 Nightblind

Top-Loading Chillers

Painted exterior
 Stainless steel interior
 Speed rail
 Castors

Most of the optional extras illustrated in this brochure are available at additional cost.

Medical/pharmacy specification (hi/lo temp & door alarms etc) is available on most cabinets.

Most cabinets can be converted for use on alternative electrical supplies e.g. for marine use.

Most cabinets can be supplied with R134a in lieu of hydrocarbon refrigerant .

Certain cabinets / specifications / options are available only to special order and minimum quantities may apply. Check with the Sales Office for details. We operate a policy of continuous Research and Development throughout our model range - All Sizes and Specifications may be subject to change without prior notice

Osborne Refrigerators have been designed and built exclusively in Britain for over 50 years and we are the leading British manufacturer of commercial refrigerators designed for the chilling and storage of wine, cold beverages and foodstuffs.

As well as our standard range of display and storage cabinets, which are specified by leading breweries, drinks manufacturers and leisure companies across the world, we also manufacture specialist milk chillers and wine cabinets.



Made in England since 1960



We operate a policy of continuous Research and Development throughout our model range
All Sizes and Specifications may be subject to change without prior notice

All Osborne products are supported by a two year parts warranty (labour warranty subject to sale conditions, warranty applies to the United Kingdom).

Osborne Refrigerators Ltd
Rose Green Road
Bognor Regis
West Sussex
PO21 3EG
United Kingdom

+44(0)1243 267711
+44(0)1243 265853
sales@osborne-ref.co.uk
www.osbornerefrigerators.uk
@osbornerefrigerators
@osbornerefrig

Conforms to UL Std 471 C22.2 NO.120
Certified to CAN/CSA

